



Technical catalogue

Modular DIN rail components

Installation contactors

Power and productivity
for a better world™



Spec-Tech Industrial Electric - www.spectechind.com - 888-773-2832

Installation Contactors



Overview 2

ESB Installation Contactors

20 A / AC-1/AC-7a **ESB20** 4
 24 A / AC-1/AC-7a **ESB24** 5
 40 A / AC-1/AC-7a **ESB40** 6
 63 A / AC-1/AC-7a **ESB63** 7

Main Technical Data 8

Lighting application 13

EN Installation Contactors - Manually/Automatic Operated

20 A / AC-1/AC-7a **EN20** 14
 24 A / AC-1/AC-7a **EN24** 15
 40 A / AC-1/AC-7a **EN40** 16

Main Technical Data 17

ESB/EN Installation Contactors

Main Accessories 19

Index 20

Modular DIN rail components

Installation Contactors ESB and EN

All over the world, commercial and industrial buildings such as hospitals, hotels, shopping and sport centers, domestic and residential installation are equipped with ABB low voltage products and systems.

From switchboard to light switch, ABB covers the complete range of equipment required for controlling and protecting electrical installations.



Typical segments

1-2 Residential installations | 3 Hotels



For controlling and remote switching, ABB offers a complete range of installation contactors that are mainly used in the following applications:

- Lighting
- Heating
- Ventilation
- Pumps and motors.

ESB and EN installation contactors are designed to match the Modular DIN rail components for common use in dedicated panels.

The ESB range includes 4 ratings from 20 A to 63 A with 2 to 4-pole version.

The EN range includes 3 ratings from 20 A to 40 A.

Many contacts variations are available for managing all application. Products comply with standards IEC60947-4-1 and IEC61095.

Construction:

The ESB20, EN20 operates with an AC solenoid system.

Types ESB24...63, EN24...40 are fitted with a DC solenoid actuator and are therefore hum-free. The noise during switching is barely audible making it beneficial for use in buildings such as hospitals, hotels or houses. An incorporated varistor protects the coil against remote lightning strikes and overvoltages up to 5 kV.

In addition, it limits the interference voltage peaks of the solenoid system.

The contactors can therefore be combined with programmable logic controllers. There is no need for a protective circuit. The solenoid system is provided with radio interference suppression. Accessories are available, such as auxiliary contacts and sealing covers.

ESB advantages:

- Powerful for lamp switching
- Operation flag indicator
- DC coil: - Noiseless and hum free
 - Low power consumption
 - Integrated overvoltage protection.

The EN contactors have a built-in toggle switch for automatic and manual operation.

EN advantages:

- Facilitate commissioning
- Functional test before start-up
- Ease maintenance operation
- High degree of safety and availability in case of automation system failure.

4 Shopping centers | 5 Hospitals | 6 Commercial & industrial buildings





20 A
AC-1/AC-7a

ESB20 Installation Contactors

AC Operated



Application

The ESB contactors are used mainly in buildings for switching and controlling lighting, heating, ventilation and pumps. They are part of the complete range of Din rail products and can be integrated easily in dedicated panels.

Certifications and Approvals



Description

The **ESB20** contactors are used for the control of single phase loads up to 20 A. They operate with an AC coil. You can choose between a various N.O. and N.C. contacts combination.

Ordering Details

Main poles	Nb of modules	Control coil voltage		Type	Order code	Pack ^(ing) pieces	Weight kg (1 pce)
		50 Hz	60 Hz				
 1	1	12 V	14 V	ESB20-20	GHE3211102R1004	10	0.14
		20 V	24 V		GHE3211102R1005	10	0.14
		24 V	28 V		GHE3211102R0001	10	0.14
		42 V	48 V		GHE3211102R0002	10	0.14
		48 V	55 V		GHE3211102R0003	10	0.14
		110 V	125...127 V		GHE3211102R0004	10	0.14
2 N.O.	1	230 V	264 V	ESB20-02	GHE3211102R0006	10	0.14
		240 V	278 V		GHE3211102R0005	10	0.14
		400 V	-		GHE3211102R0007	10	0.14
		12 V	14 V		GHE3211202R1004	10	0.14
		20 V	24 V		GHE3211202R1005	10	0.14
		24 V	28 V		GHE3211202R0001	10	0.14
2 N.C.	1	42 V	48 V	ESB20-02	GHE3211202R0002	10	0.14
		48 V	55 V		GHE3211202R0003	10	0.14
		110 V	125...127 V		GHE3211202R0004	10	0.14
		230 V	264 V		GHE3211202R0006	10	0.14
		240 V	278 V		GHE3211202R0005	10	0.14
		400 V	-		GHE3211202R0007	10	0.14
1 N.O.	1	12 V	14 V	ESB20-11	GHE3211302R1004	10	0.14
		20 V	24 V		GHE3211302R1005	10	0.14
		24 V	28 V		GHE3211302R0001	10	0.14
		42 V	48 V		GHE3211302R0002	10	0.14
		48 V	55 V		GHE3211302R0003	10	0.14
		110 V	125...127 V		GHE3211302R0004	10	0.14
1 N.C.	1	230 V	264 V	ESB20-11	GHE3211302R0006	10	0.14
		240 V	278 V		GHE3211302R0005	10	0.14
		400 V	-		GHE3211302R0007	10	0.14

Main Technical Data

For complete technical data see 1SBC103005S0201.pdf

Main poles acc to IEC 60947-4-1 and IEC 61095	Rated operational voltage U_e	250 V
	I_e AC-1 / AC-7a Rated operational current (for air temperature close to contactor $\theta \leq 55^\circ\text{C}$)	20 A
	AC-3 / AC-7b Ratings (for air temperature close to contactor $\theta \leq 55^\circ\text{C}$)	
	Rated operational power	1 phase 230 V 1.1 kW
	I_e Rated operational current	1 phase 230 V 9 A
Magnet system	Coil operating limits (acc. to IEC 60947-4-1)	0.85 ... 1.1 U_e (at $\theta \leq 55^\circ\text{C}$)
	Average pull-in coil consumption value	8 VA / 5 W
	Average holding coil consumption value	3.2 VA / 1.2 W
Connecting capacity	Main pole terminals	Rigid 1 x 1.5 ... 10 mm ² 2 x 1.5 ... 4 mm ²
	Coil terminals	Rigid 1 x 0.5 ... 4 mm ² 2 x 0.75 ... 2.5 mm ²

Mounting positions

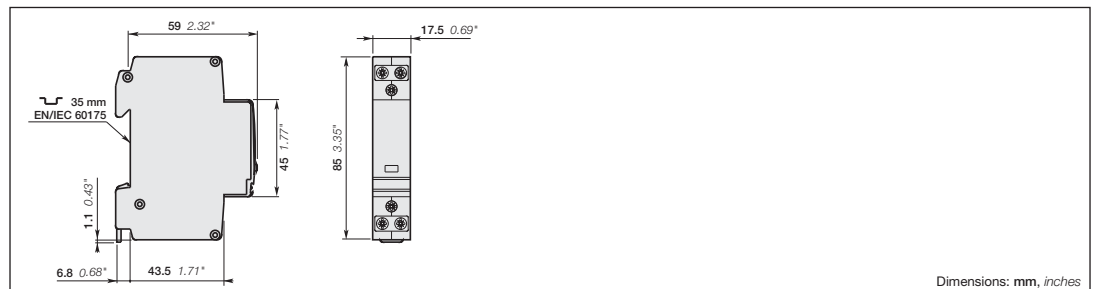
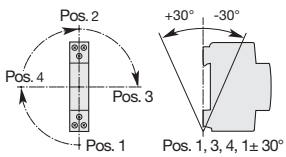

Dimensions: mm, inches



24 A
AC-1/AC-7a

ESB24 Installation Contactors

AC / DC Operated



Application

The ESB contactors are used mainly in buildings for switching and controlling lighting, heating, ventilation and pumps. They are part of the complete range of Din rail products and can be integrated easily in dedicated panels.

Description

The **ESB24** contactors are used for the control of single and three-phases loads up to 24 A. Due to their DC solenoid actuator, the **ESB24** can be connected to AC or DC voltages.

This provides the following benefits:

Hum-free operating system, no vibration, silent in operation, low power consumption, integrated high overvoltage protection 5 kV. You can choose between a various N.O. and N.C. contacts combination.

Main accessories:

Auxiliary contact blocks **EH04**.

Certifications and Approvals

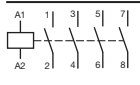
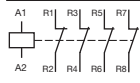
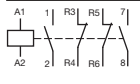
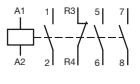
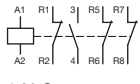

Ordering Details

Main poles	Nb of modules	Control coil voltage		Type	Order code	Pack ^(ing) pieces	Weight kg (1 pce)
		40... 450 Hz	DC				
 4 N.O.	2	12 V	12 V	ESB24-40	GHE3291102R1004	5	0.28
		24 V	24 V		GHE3291102R0001	5	0.28
		42 V	42 V		GHE3291102R0002	5	0.28
		48 V	48 V		GHE3291102R0003	5	0.28
		110...120 V	110...120 V		GHE3291102R0004	5	0.28
		230...240 V	230...240 V		GHE3291102R0006	5	0.28
		400...415 V	400...415 V		GHE3291102R0007	5	0.28
 4 N.C.	2	12 V	12 V	ESB24-04	GHE3291202R1004	5	0.28
		24 V	24 V		GHE3291202R0001	5	0.28
		42 V	42 V		GHE3291202R0002	5	0.28
		48 V	48 V		GHE3291202R0003	5	0.28
		110...120 V	110...120 V		GHE3291202R0004	5	0.28
		230...240 V	230...240 V		GHE3291202R0006	5	0.28
		400...415 V	400...415 V		GHE3291202R0007	5	0.28
 2 N.O. 2 N.C.	2	12 V	12 V	ESB24-22	GHE3291302R1004	5	0.28
		24 V	24 V		GHE3291302R0001	5	0.28
		42 V	42 V		GHE3291302R0002	5	0.28
		48 V	48 V		GHE3291302R0003	5	0.28
		110...120 V	110...120 V		GHE3291302R0004	5	0.28
		230...240 V	230...240 V		GHE3291302R0006	5	0.28
		400...415 V	400...415 V		GHE3291302R0007	5	0.28
 3 N.O. 1 N.C.	2	12 V	12 V	ESB24-31	GHE3291602R1004	5	0.28
		24 V	24 V		GHE3291602R0001	5	0.28
		42 V	42 V		GHE3291602R0002	5	0.28
		48 V	48 V		GHE3291602R0003	5	0.28
		110...120 V	110...120 V		GHE3291602R0004	5	0.28
		230...240 V	230...240 V		GHE3291602R0006	5	0.28
		400...415 V	400...415 V		GHE3291602R0007	5	0.28
 1 N.O. 3 N.C.	2	12 V	12 V	ESB24-13	GHE3291702R1004	5	0.28
		24 V	24 V		GHE3291702R0001	5	0.28
		42 V	42 V		GHE3291702R0002	5	0.28
		48 V	48 V		GHE3291702R0003	5	0.28
		110...120 V	110...120 V		GHE3291702R0004	5	0.28
		230...240 V	230...240 V		GHE3291702R0006	5	0.28
		400...415 V	400...415 V		GHE3291702R0007	5	0.28

Main Technical Data

For complete technical data see 1SBC103005S0201.pdf

Main poles acc to. IEC 60947-4-1 and IEC 61095	Rated operational voltage U_e	400 V
	I_e AC-1 / AC-7a Rated operational current (for air temperature close to contactor $\theta \leq 55^\circ\text{C}$)	24 A
	AC-3 / AC-7b Ratings (for air temperature close to contactor $\theta \leq 55^\circ\text{C}$)	
	Rated operational power	3 phases 400 V 4 kW
	I_e Rated operational current	3 phases 400 V 9 A
Magnet system	Coil operating limits (acc. to IEC 60947-4-1)	0.85 ... 1.1 U_e (at $\theta \leq 55^\circ\text{C}$)
	Average pull-in coil consumption value	4 VA / 4 W
	Average holding coil consumption value	4 VA / 4 W
Connecting capacity	Main pole terminals	Rigid 1 x 1.5 ... 10 mm ²
		2 x 1.5 ... 4 mm ²
	Coil terminals	Rigid 1 x 1 ... 4 mm ²
		2 x 0.75 ... 2.5 mm ²

Mounting positions

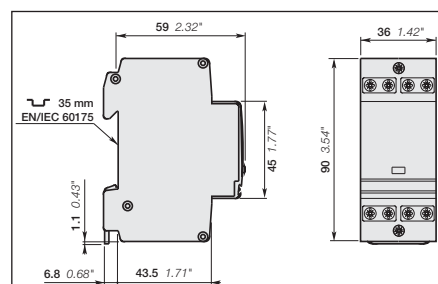
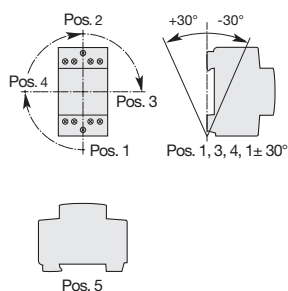

Dimensions: mm, inches

1SBC103005S0201



40 A
AC-1/AC-7a

ESB40 Installation Contactors

AC / DC Operated



Application

The ESB contactors are used mainly in buildings for switching and controlling lighting, heating, ventilation and pumps. They are part of the complete range of Din rail products and can be integrated easily in dedicated panels.

Description

The **ESB40** contactors are used for the control of single and three-phases loads up to 40 A. Due to their DC solenoid actuator, the **ESB40** can be connected to AC or DC voltages. This provides the following benefits:

Hum-free operating system, no vibration, silent in operation, low power consumption, integrated high overvoltage protection 5 kV. You can choose between a various N.O. and N.C. contacts combination.

Main accessories:

Auxiliary contact blocks **EH04**.

Certifications and Approvals

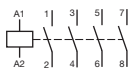
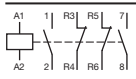
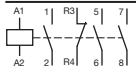
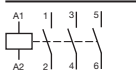
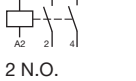

Ordering Details

Main poles	Nb of modules	Control coil voltage		Type	Order code	Pack ^(ing) pieces	Weight kg (1 pce)	
		40... 450 Hz	DC					
 4 N.O.	3	12 V	12 V	ESB40-40	GHE3491102R1004	3	0.40	
		24 V	24 V		GHE3491102R0001	3	0.40	
		42 V	42 V		GHE3491102R0002	3	0.40	
		48 V	48 V		GHE3491102R0003	3	0.40	
		110...120 V	110...120 V		GHE3491102R0004	3	0.40	
		230...240 V	230...240 V		GHE3491102R0006	3	0.40	
 2 N.O. 2 N.C.	3	24 V	24 V	ESB40-22	GHE3491302R0001	3	0.40	
		230 V	230 V		GHE3491302R0006	3	0.40	
		24 V	24 V		ESB40-31	GHE3491602R0001	3	0.40
		230 V	230 V			GHE3491602R0006	3	0.40
 3 N.O. 1 N.C.	3	24 V	24 V	ESB40-30	GHE3491502R0001	3	0.39	
		230 V	230 V		GHE3491502R0006	3	0.39	
		400 V	400 V		GHE3491502R0007	3	0.39	
 3 N.O.	3	24 V	24 V	ESB40-20	GHE3491402R0001	3	0.38	
		230 V	230 V		GHE3491402R0006	3	0.38	
 2 N.O.	3	24 V	24 V	ESB40-20	GHE3491402R0001	3	0.38	
		230 V	230 V		GHE3491402R0006	3	0.38	

Main Technical Data

For complete technical data see 1SBC103005S0201.pdf

Main poles	Rated operational voltage U_e	400 V
	acc to IEC 60947-4-1 and IEC 61095 I_e AC-1 / AC-7a Rated operational current (for air temperature close to contactor $\theta \leq 55^\circ\text{C}$) AC-3 / AC-7b Ratings (for 1500 r.p.m., 50 Hz or 1800 r.p.m., 60 Hz, 3-phase motors) (for air temperature close to contactor $\theta \leq 55^\circ\text{C}$)	40 A
Magnet system	Rated operational power 3 phases	400 V 11 kW
	I_e Max. Rated operational current 3 phases	400 V 22 A
Connecting capacity	Coil operating limits (acc. to IEC 60947-4-1)	0.85 ... 1.1 U_e (at $\theta \leq 55^\circ\text{C}$)
	Average pull-in coil consumption value	5 VA / 5 W
	Average holding coil consumption value	5 VA / 5 W
Connecting capacity	Main pole terminals	Rigid 1 x 1.5 ... 25 mm ²
	Coil terminals	Rigid 2 x 1.5 ... 10 mm ²
		1 x 1 ... 4 mm ²
		2 x 0.75 ... 2.5 mm ²

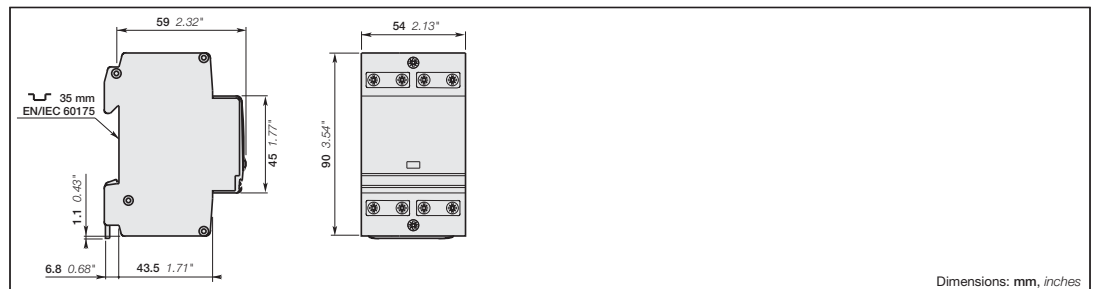
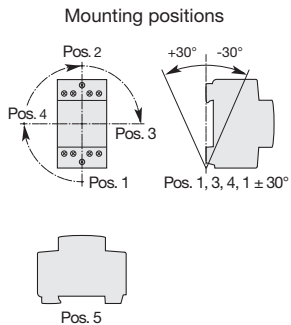



63 A
AC-1/AC-7a

ESB63 Installation Contactors

AC / DC Operated



Application

The ESB contactors are used mainly in buildings for switching and controlling lighting, heating, ventilation and pumps. They are part of the complete range of Din rail products and can be integrated easily in dedicated panels.

Description

The **ESB63** contactors are used for the control of single and three-phases loads up to 63 A. Due to their DC solenoid actuator, the **ESB63** can be connected to AC or DC voltages.

This provides the following benefits:

Hum-free operating system, no vibration, silent in operation, low power consumption, integrated high overvoltage protection 5 kV. You can choose between a various N.O. and N.C. contacts combination.

Main accessories:

Auxiliary contact blocks **EH04**.

Certifications and Approvals

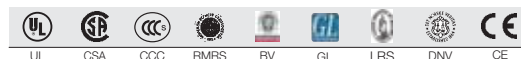

Ordering Details

Main poles	Nb of modules	Control coil voltage		Type	Order code	Pack ^(ing) pieces	Weight kg (1 pce)
		40... 450 Hz	DC				
 4 N.O.	3	12 V	12 V	ESB63-40	GHE3691102R1004	3	0.42
		24 V	24 V		GHE3691102R0001	3	0.42
		42 V	42 V		GHE3691102R0002	3	0.42
		48 V	48 V		GHE3691102R0003	3	0.42
		110...120 V	110...120 V		GHE3691102R0004	3	0.42
		230...240 V	230...240 V		GHE3691102R0006	3	0.42
 2 N.O. 2 N.C.	3	400...415 V	400...415 V	ESB63-22	GHE3691102R0007	3	0.42
		415 V	415 V		GHE3691102R0008	3	0.42
		400 V	400 V		GHE3691302R0007	3	0.42
 3 N.O.	3	110 V	110 V	ESB63-31	GHE3691602R0004	3	0.42
		230 V	230 V		GHE3691602R0006	3	0.42
 1 N.O. 1 N.C.	3	230 V	230 V	ESB63-30	GHE3691502R0006	3	0.41
		400 V	400 V		GHE3691502R0007	3	0.41
 3 N.O.	3	24 V	24 V	ESB63-20	GHE3691402R0001	3	0.40
		230 V	230 V		GHE3691402R0006	3	0.40
 2 N.O.	3	230 V	230 V	ESB63-11	GHE3691802R0006	3	0.40
		400 V	400 V				
 1 N.O. 1 N.C.	3	230 V	230 V	ESB63-11	GHE3691802R0006	3	0.40
		400 V	400 V				

Main Technical Data

For complete technical data see 1SBC103005S0201.pdf

Main poles acc to. IEC 60947-4-1 and IEC 61095	Rated operational voltage U_e	400 V
	I_e AC-1 / AC-7a Rated operational current (for air temperature close to contactor $\theta \leq 55^\circ\text{C}$)	63 A
	AC-3 / AC-7b Ratings (for 1500 r.p.m., 50 Hz or 1800 r.p.m., 60 Hz, 3-phase motors) (for air temperature close to contactor $\theta \leq 55^\circ\text{C}$)	
	Rated operational power	3 phases 400 V 15 kW
Magnet system	I_e Max. rated operational current	3 phases 400 V 30 A
	Coil operating limits (acc. to IEC 60947-4-1)	0.85 ... 1.1 U_e (at $\theta \leq 55^\circ\text{C}$)
	Average pull-in coil consumption value	65 VA / 65 W
Connecting capacity	Average holding coil consumption value	4.2 VA / 4.2 W
	Main pole terminals	Rigid 1 x 1.5 ... 25 mm ²
	Coil terminals	Rigid 2 x 1.5 ... 10 mm ²
		1 x 1 ... 4 mm ²
		2 x 0.75 ... 2.5 mm ²

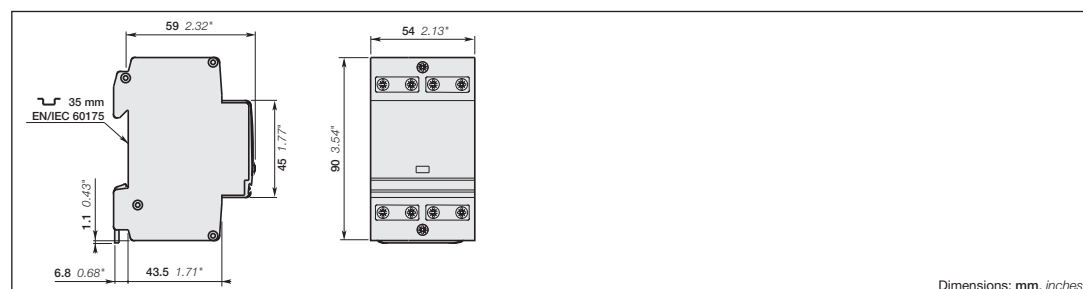
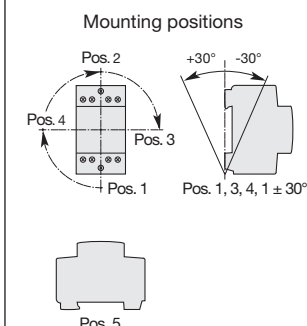

ESB Installation Contactors

Technical Data

Main Pole - Utilization Characteristics according to IEC

Contactor types:	AC operated AC / DC operated	ESB20	ESB24	ESB40	ESB63
Rated operational voltage U_e max.	V	AC: 250, DC: 220	AC: 400, DC: 220		
Rated frequency limits	Hz	50/60, DC			
Utilization category AC-1 / AC-7a for air temperature close to contactor $< 55^\circ\text{C}$ Max. rated operational current I_e AC-1 / AC-7a					
	N.O. A	20	24	40	63
	N.C. A	20	24	30	30
Utilization category AC-3 / AC-7b for air temperature close to contactor $\leq 55^\circ\text{C}$ Max. rated operational current I_e AC-3/AC-7b					
230 V - 1 phase N.O.	A	9	9	22	30
400 V - 3 phases N.O.	A	-	9	22	30
Rated operational power AC-3					
230 V - 1 phase	kW	1.1	1.3	3.7	5
400 V - 3 phases	kW	-	4	11	15
Rated making capacity AC-3 10 x I_e / AC-3					
Rated breaking capacity AC-3 8 x I_e / AC-3					
Short-circuit protection for contactors gG type fuse					
	A	20	35	63	80
Rated short-time withstand current I_{cw} at 40°C ambient temp., in free air, from a cold state					
10 s	A	72		176	240
Heat dissipation per pole I_e/AC-1/AC-7a					
	W	1	3	4	6
Max. electrical switching frequency					
- for AC-1 / AC-7a	cycles/h	300			
- for AC-3 / AC-7b	cycles/h	600			
Electrical durability					
- for AC-1 / AC-7a	cycles	150000	150000	150000	150000
- for AC-3 / AC-7b	cycles	150000	500000	170000	240000
Mechanical durability - millions of operating cycles					
		1			

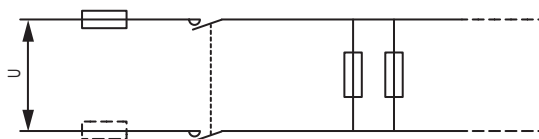

Single-phase (AC-1, AC-7a)

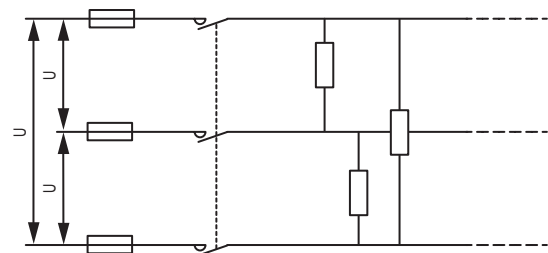

Three-phase (AC-1, AC-7a)

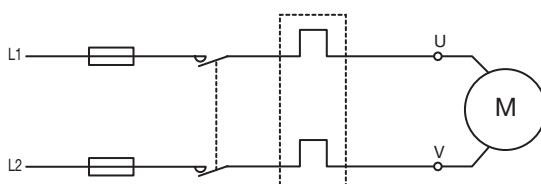

Single-phase (AC-7b)

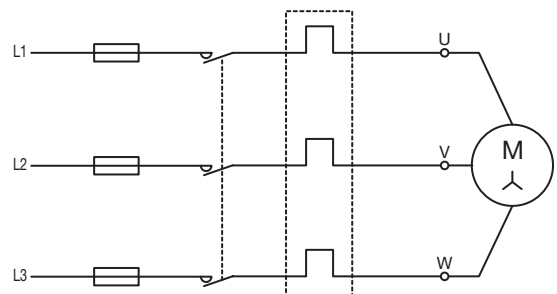

Three-phase (AC-7b, AC-3)



ESB Installation Contactors

Technical Data

Main Pole - Utilization Characteristics according to UL/CSA

Contactor types:	AC operated AC / DC operated		ESB20	ESB24	ESB40	ESB63
General use rating						
Amp rating	240 V	A	20	-	-	-
	480 V	A	-	24	40	63
Motor rating						
Amp rating						
	120 V - 1 phase	A	9.8	-	-	-
	240 V - 1 phase N.O.	A	9.8	9.6	22	28
		A	8	9.6	22	30
	440 - 480 V - 3 phases N.O.	A	-	7.6	21	21
		A		3.4	-	-
Motor power						
	120 V - 1 phase	hp	1/2	-	-	-
	240 V - 1 phase	hp	1	3	7.5	10
	440 - 480 V - 3 phases	hp	-	5	15	15
Short-circuit protection for contactors without thermal O/L relay - Motor protection excluded						
Fuse rating, 480 V		A	25	25 / K5	40 / K5	75 / K5
Fuse type, 600 V			-	-	-	-
Max. electrical switching frequency						
- for general use		cycles/h	300			
- for motor use		cycles/h	600			

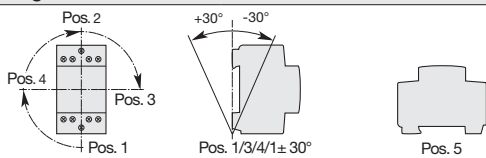
General Technical Data

Rated insulation voltage U_i				
according to IEC 60947-4-1	V	400	500	
according to UL/CSA	V	240	600	
Rated impulse withstand voltage U_{imp}	kV	6		
Standards		IEC 60947-4-1 / EN 60947-4-1 and IEC 61095 / EN 61095, UL 508, CSA C22.2 N°14-05		
Air temperature close to contactor				
- for operation at 0.85 ... 1.1 U_c	°C	-25 ... +55 (Type ESB24...63: for ambient temperature > 40 °C, add ESB-DIS (1/2 module) at every second contactor)		
- for storage	°C	-40 ... +80		
Climatic withstand		IEC 60068-2-30, UTE 63-100 execution 1*		
Operating altitude	m	≤ 2000		
Shock withstand		10 g / 4 ms / axes X Y Z		
Mounting positions				
Pos 1, 3, 4, 1±30°		Pos. 1/3/4/1±30°		
Pos 5 : not allowed for ESB20		Pos. 5		
Fixing				
on rail acc. to IEC 60715 and EN 60715				

* ESB20 only





ESB Installation Contactors

Technical Data

Magnet System Characteristics

Contactor types:	AC operated AC / DC operated	ESB20				ESB24		ESB40		ESB63	
Rated operational voltage U_e max.		0.85 ... 1.1 x U_c (at $\theta \leq 55$ °C)									
	- at 50 Hz	V	12 ... 400		12 ... 415		24 ... 415				
	- at 60 Hz	V	14 ... 380		12 ... 415		24 ... 415				
	- at 400 Hz	V	-		12 ... 415		24 ... 415				
	DC	V	-		12 ... 415		24 ... 415				
Coil operating limits acc. to IEC 60947-4-1		approx. 20 ... 75 %									
Drop-out voltage in % of U_c		approx. 10 ... 75 %									
Frequency range		Hz		50/60		DC, 50 ... 400					
Coil consumption											
Average pull-in value		VA/W	8 / 5		4 / 4		5 / 5		65 / 65		
Average holding value		VA/W	3.2 / 1.2		4 / 4		5 / 5		4.2 / 4.2		
Operating time											
between coil energization and:											
	- N.O. contact closing	ms	12		40						
between coil de-energization and:											
	- N.O. contact opening	ms	12		40						

Connecting Characteristics

Contactor types:	AC operated AC / DC operated	ESB20				ESB24		ESB40		ESB63	
Connecting capacity (min. ... max.)											
Main pole terminals											
	Rigid		1 x mm ²		1.5 ... 10		1.5 ... 25				
			2 x mm ²		1.5 ... 4		1.5 ... 10				
Capacity acc. to UL/CSA		AWG		14-8		16-8		16-4			
Coil terminals											
	Rigid		1 x mm ²		0.5 ... 4		1 ... 4				
			2 x mm ²		0.75 ... 2.5						
Capacity acc. to UL/CSA		AWG		18-14		16-10					
Degree of protection											
acc. to IEC 60947-1 / EN 60947-1 and IEC 60529 / EN 60529											
Protection against direct contact in acc. with EN 50274											
All terminals		IP20									
Screwdriver type											
Main poles		Flat Ø 5 / Pozidriv 1				Flat Ø 7.5 / Pozidriv 2					
Coil terminals		Flat Ø 5 / Pozidriv 1				Flat Ø 5 / Pozidriv 1					
Stripping length											
Main poles		mm	10		13						
Coil terminals		mm	7								
Tightening torque											
Main poles		Nm	1.2		1		2.5				
Coil terminals		Nm	0.9								

ESB Installation Contactors

Technical Data

EH04... Auxiliary Contact Block - Utilization Characteristics according to IEC

Contactor types:	AC operated AC / DC operated	ESB20	ESB24	ESB40	ESB63
Rated operational voltage U_e max.	V	-	500		
Conventional free air thermal current I_{th} $\theta \leq 40^\circ\text{C}$	A	-	6		
Rated frequency limits	Hz	-	50/60		
Rated operational current I_e / AC-15					
acc. to IEC 60947-5-1	240 V 50/60 Hz	A	4		
	415 V 50/60 Hz	A	3		
	500 V 50/60 Hz	A	2		
Making capacity acc. to IEC 60947-5-1		-	11 x I_e AC-15		
Breaking capacity acc. to IEC 60947-5-1		-	11 x I_e AC-15		
Short-circuit protection gl type fuse	A	-	10		
Minimum switching capacity with failure rate acc. to IEC 60947-5-4	V/mA	-	17 / 5		
Heat dissipation per pole at 6 A	W	-	0.1		

Electrical durability

AC-1 / 400 V / 3-phase for ESB20...63

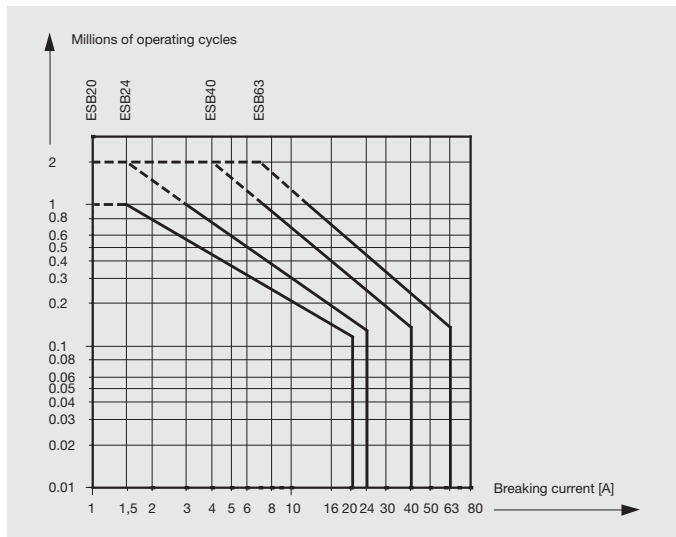

AC-3 / 400 V / 3-phase for ESB24...63

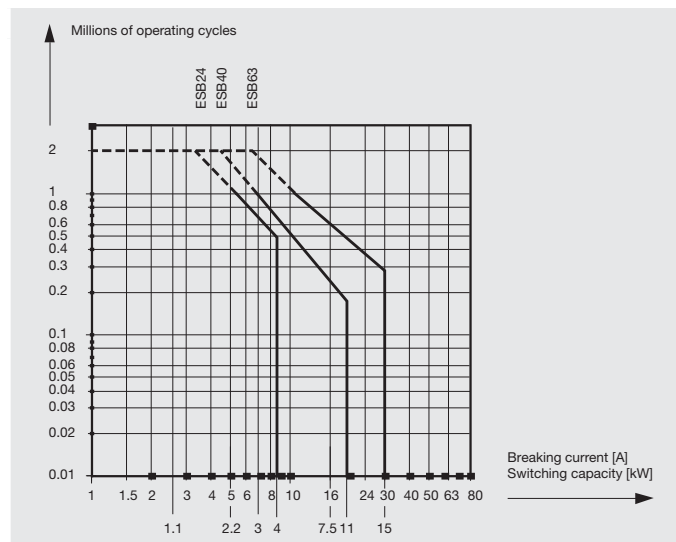

ESB Installation Contactors

Technical Data

DC-1/DC-3 switching DC with N.O. contacts (N.O.)

Type	Rated operating voltage U_e	DC-1 (L/R ≤ 1 ms)			DC-3 (L/R ≤ 2 ms)		
		1 current path	2 current paths in series	3 current paths in series	1 current path	2 current paths in series	3 current paths in series
ESB20-20	24 V DC	20 A	20 A	-	15 A	20 A	-
	48 V DC	15 A	20 A	-	7 A	15 A	-
	60 V DC	15 A	20 A	-	5 A	10 A	-
	110 V DC	5 A	15 A	-	1.5 A	5 A	-
	220 V DC	0.5 A	5 A	-	0.2 A	1.5 A	-
ESB24	24 V DC	24.0 A	24.0 A	24.0 A	16.0 A	24.0 A	24.0 A
	48 V DC	21.0 A	24.0 A	24.0 A	8.0 A	18.0 A	24.0 A
	60 V DC	17.0 A	24.0 A	24.0 A	4.0 A	14.0 A	24.0 A
	110 V DC	7.0 A	16.0 A	24.0 A	1.6 A	6.5 A	16.0 A
	220 V DC	0.9 A	4.5 A	13.0 A	0.2 A	1.0 A	4.0 A
ESB40	24 V DC	40.0 A	40.0 A	40.0 A	19.0 A	40.0 A	40.0 A
	48 V DC	23.0 A	40.0 A	40.0 A	10.0 A	20.0 A	40.0 A
	60 V DC	18.0 A	32.0 A	40.0 A	5.0 A	16.0 A	34.0 A
	110 V DC	8.0 A	17.0 A	30.0 A	1.8 A	7.0 A	18.0 A
	220 V DC	1.0 A	5.0 A	15.0 A	0.3 A	1.1 A	4.5 A
ESB63	24 V DC	50.0 A	63.0 A	63.0 A	21.0 A	44.0 A	63.0 A
	48 V DC	25.0 A	43.0 A	63.0 A	11.0 A	22.0 A	47.0 A
	60 V DC	20.0 A	35.0 A	60.0 A	5.5 A	18.0 A	38.0 A
	110 V DC	9.0 A	19.0 A	33.0 A	2.0 A	8.0 A	21.0 A
	220 V DC	1.1 A	5.5 A	17.0 A	0.3 A	1.2 A	5.0 A

DC-1/DC-3 switching DC with N.C. contacts (N.C.)

Type	Rated operating voltage U_e	DC-1 (L/R ≤ 1 ms)			DC-3 (L/R ≤ 2 ms)		
		1 current path	2 current paths in series	3 current paths in series	1 current path	2 current paths in series	3 current paths in series
ESB20-02	24 V DC	14 A	20 A	-	6 A	10 A	-
	48 V DC	7 A	14 A	-	3 A	6 A	-
	60 V DC	4.5 A	10 A	-	2 A	4 A	-
	110 V DC	1.5 A	4.4 A	-	0.6 A	1.8 A	-
	220 V DC	0.2 A	1.5 A	-	0.1 A	0.6 A	-
ESB24	24 V DC	14.5 A	24.0 A	24.0 A	6.3 A	11.0 A	19.0 A
	48 V DC	7.5 A	12.5 A	22.0 A	3.1 A	5.4 A	9.4 A
	60 V DC	4.5 A	10.0 A	17.5 A	2.0 A	4.3 A	7.5 A
	110 V DC	1.6 A	4.4 A	9.5 A	0.7 A	1.9 A	4.1 A
	220 V DC	0.2 A	1.4 A	3.8 A	0.1 A	0.6 A	1.6 A

ESB Installation Contactors - Lighting Application

Technical Data

Switching of lamp load

The following table shows the number of lamps which can be connected per phase at 230 V, 50 Hz. Air temperature, near the contactor, must be limited to 55 °C.

Please, note that the given capacitor load must not be exceeded, otherwise inadmissible high inrush current peaks could occur.

These are influenced by the length and cross section of the wire used, the type of power supply unit and specifications of the lamp brand.

For these reasons, values in the table are for information only.

Numbers are given for a 230 V voltage distributed between phase and neutral: single phase (phase + neutral) or three-phases (3 phases + neutral), lamps are wired in star connection.

In the case of three-phase supply without neutral, 230 V phase-to-phase, the permissible number of lamps per phase will be that given in the table multiplied by 0.58.

Lamp type	Lamp data		Permissible number of lamps per phase (230 V, 50 Hz)				Capacitor µF
	Watt	I _n A	ESB20	ESB24	ESB40	ESB63	
Incandescent lamps	60	0.26	21	25	54	83	
	100	0.43	13	15	32	50	
	200	0.87	7	7	16	25	
	300	1.30	4	5	11	16	
	500	2.17	3	3	6	10	
	1000	4.35	1	1	3	5	
Fluorescent lamps Uncompensated and series compensation	15	0.33	40	30	100	155	
	20	0.37	37	26	85	135	
	40	0.43	32	20	65	105	
	42	0.54	26	16	52	85	
	58	0.64	21	12	40	65	
	65	0.67	21	12	40	65	
	115	1.3	9	5	18	28	
	140	1.5	9	5	18	28	
Two-lamp circuit	2 x 20	2 x 0.13	2 x 22	2 x 26	2 x 85	2 x 140	
	2 x 40	2 x 0.22	2 x 17	2 x 20	2 x 65	2 x 105	
	2 x 42	2 x 0.24	2 x 13	2 x 16	2 x 52	2 x 65	
	2 x 58	2 x 0.34	2 x 10	2 x 12	2 x 40	2 x 65	
	2 x 65	2 x 0.34	2 x 10	2 x 12	2 x 40	2 x 65	
	2 x 115	2 x 0.65	2 x 4	2 x 5	2 x 18	2 x 28	
	2 x 140	2 x 0.75	2 x 4	2 x 5	2 x 18	2 x 28	
	Parallel compensation	15	0.11	16	8	16	67
20		0.13	16	8	16	67	4.5
40		0.22	16	8	16	67	4.5
42		0.24	13	6	12	50	6
58		0.34	11	5	10	43	7
65		0.34	11	5	10	43	7
115		0.65	4	2	4	17	18
140		0.75	4	2	4	17	18
High pressure mercury-vapor lamps Uncompensated	50	0.61	30	14	36	50	
	80	0.8	15	10	27	38	
	125	1.15	10	7	19	26	
	250	2.15	6	4	10	14	
	400	3.25	2	2	7	10	
	700	5.40	2	1	4	6	
	1000	7.5	1	1	3	4	
	2000/ 400 V	8	-	1	3	4	
Parallel compensation	50	0.28	4	5	10	43	7
	80	0.41	3	4	8	37	8
	125	0.65	2	3	6	26	10
	250	1.22	1	2	3	15	18
	400	1.95	-	1	3	10	25
	700	3.45	-	-	1	5	45
	1000	4.8	-	-	1	4	60
	2000/ 400 V	5.45	-	1	2	3	35
Lamps with electronic power supply units	1 x 18	-	15	24	55	76	
	2 x 18	-	8	18	34	48	
	1 x 36	-	12	16	34	47	
	2 x 36	-	7	11	20	29	
	1 x 58	-	11	14	32	46	
	2 x 58	-	6	8	17	24	

Lamp type	Lamp data		Permissible number of lamps per phase (230 V, 50 Hz)				Capacitor µF	
	Watt	I _n A	ESB20	ESB24	ESB40	ESB63		
Halogen metal-vapor lamps Uncompensated	35	0.53	9	10	28	38		
	70	1	4	5	14	20		
	150	1.8	3	3	8	11		
	250	3	1	2	5	7		
	400	3.5	1	1	4	6		
	1000	9.5	-	-	1	2		
	2000	16.5	-	-	1	1		
	2000/ 3500/ 400 V	10.5	-	-	2	2		
	Parallel compensation	35	0.25	-	5	11	30	6
		70	0.45	-	3	5	18	12
150		0.75	-	1	3	9	20	
250		1.5	-	1	2	7	33	
400		2.5	-	-	2	6	35	
1000		5.8	-	-	-	2	95	
2000		11.5	-	-	-	1	148	
2000/ 3500/ 400 V		6.6	-	-	1	2	58	
Low pressure sodium-vapor lamps Uncompensated	35	1.5	10	8	22	30		
	55	1.5	10	8	22	30		
	90	2.4	5	5	13	19		
	135	3.5	3	3	10	13		
	150	3.3	3	3	10	14		
	180	3.3	3	3	10	14		
	200	2.3	3	5	14	20		
	Parallel compensation	35	0.31	-	1	4	15	20
55		0.42	-	1	4	15	20	
90		0.63	-	1	3	10	30	
135		0.94	-	-	2	7	45	
150		1.0	-	-	2	8	40	
180		1.16	-	-	2	8	40	
High pressure sodium-vapor lamps Uncompensated	200	1.32	-	1	3	12	25	
	150	1.8	3	4	15	20		
	250	3.0	2	3	9	15		
	330	3.7	1	2	8	10		
	400	4.7	-	1	6	8		
	1000	10.3	-	-	3	4		
Parallel compensation	150	0.83	-	1	3	15	20	
	250	1.5	-	1	2	9	33	
	330	2.0	-	-	2	7	40	
	400	2.4	-	-	1	6	48	
	1000	6.3	-	-	-	2	106	
	Transformers for halogen low voltage lamps (12 or 24 V AC)	Transformers for Watt		Permissible number of transformers per circuit (230 V, 50 Hz)				
20			40	50	110	174		
50			20	24	50	80		
75			13	16	35	54		
100			10	12	27	43		
150			7	9	19	29		
200			5	6	14	23		
300			3	4	9	14		

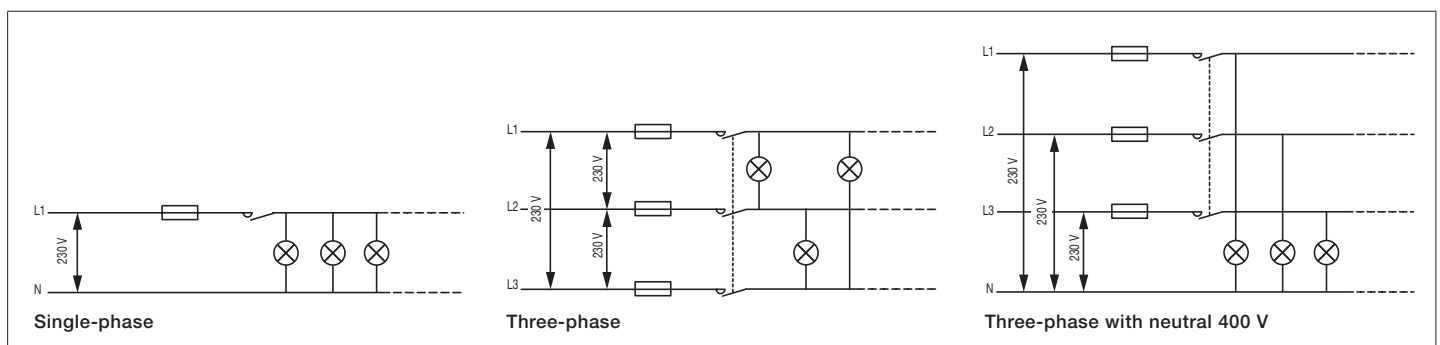



20 A
AC-1/AC-7a

EN20 Installation Contactors - Manually / Automatic Operated

AC Operated



Application

The EN contactors are used mainly in buildings for switching and controlling lighting, heating, ventilation and pumps. They are part of the complete range of Din rail products and can be integrated easily in dedicated panels.

Certifications and Approvals



Description

The EN20 contactors are used for the control of single phase loads up to 20 A. They operate with an AC coil.

EN contactors have a built-in toggle switch to select between three function modes:

Off position, automatic run (normal contactor function), manual override with a return to Auto the next time the coil is energized.

This offers many advantages as:

You can make functional test before installation start-up. It can be used for maintenance operation, to change lamps and test it. It provides higher safety and drop out as you can switch the application manually.

The toggle switch is also used for household application like water heating where double tariff of kWh is used.

Ordering Details

Main poles	Nb of modules	Control coil voltage		Type	Order code	Pack ^(ing) pieces	Weight kg (1 pce)
		50 Hz	60 Hz				
	1	24 V	28 V	EN20-20	GHE3221101R0001	10	0.14
		230 V	264 V		GHE3221101R0006	10	0.14

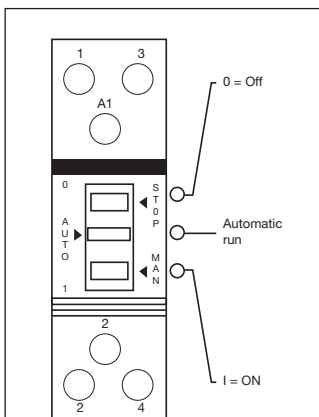

Main Technical Data

For complete technical data see 1SBC103005S0201.pdf

Main poles acc to. IEC 60947-4-1 and IEC 61095	Rated operational voltage U_e	250 V
	I_e AC-1 / AC-7a Rated operational current (for air temperature close to contactor $\theta \leq 55$ °C)	20 A
Magnet system	P_e AC-1 Rated operational power	230 V 4 kW
	Coil operating limits (acc. to IEC 60947-4-1)	0.85 ... 1.1 U_e (at $\theta \leq 55$ °C)
	Average pull-in coil consumption value	8 VA / 5 W
Connecting capacity	Average holding coil consumption value	3.2 VA / 1.2 W
	Main pole terminals	Rigid 1 x 1.5 ... 10 mm ² 2 x 1.5 ... 4 mm ²
	Coil terminals	Rigid 1 x 0.5 ... 4 mm ² 2 x 0.75 ... 2.5 mm ²

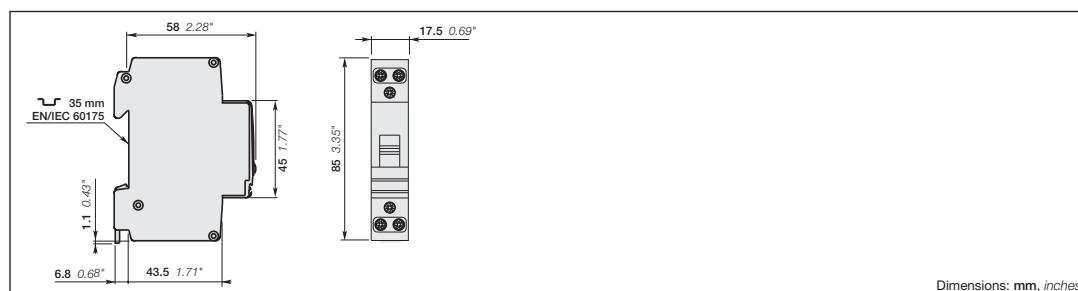
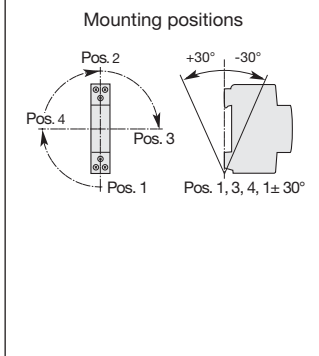



24 A
AC-1/AC-7a

EN24 Installation Contactors - Manually / Automatic Operated

AC / DC Operated



Application

The EN contactors are used mainly in buildings for switching and controlling lighting, heating, ventilation and pumps. They are part of the complete range of Din rail products and can be integrated easily in dedicated panels.

Certifications and Approvals



Description

The EN24 contactors are used for the control of single and three-phase loads up to 24 A. They operate with a DC coil.

EN contactors have a built-in toggle switch to select between three function modes:

Off position, automatic run (normal contactor function), manual Override with a return to Auto the next time the coil is energized.

This offers many advantages as:

You can make functional test before installation start-up, it can be used for maintenance operation, to change lamps and test it, it provide higher safety and drop out as you can switch the application manually.

The toggle switch is also used for household application like water heating where double tariff of kWh is used.

Ordering Details

Main poles	Nb of modules	Control coil voltage		Type	Order code	Pack ⁽ⁱⁿ⁾ pieces	Weight kg (1 pce)
		40...450 Hz	DC				
 2 4 N.O.	2	24 V	24 V	EN24-40	GHE3261101R0001	5	0.24
		230/240 V	230/240 V				
 2 3 N.O. 1 N.C.	2	24 V	24 V	EN24-31	GHE3261601R0001	5	0.24
		230/240 V	230/240 V				
 2 3 N.O.	2	230/240 V	230/240 V	EN24-30	GHE3261501R0006	5	0.23

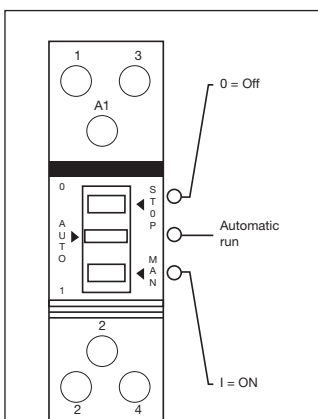

Main Technical Data

For complete technical data see 1SBC103005S0201.pdf

Main poles acc to IEC 60947-4-1 and IEC 61095	Rated operational voltage U_e	400 V
	I_e AC-1 / AC-7a Rated operational current (for air temperature close to contactor $\theta \leq 55^\circ\text{C}$)	24 A
	P_e AC-1 Rated operational power	230 V: 5.3 kW 400 V: 16 kW
Magnet system	Coil operating limits (acc. to IEC 60947-4-1)	0.85 ... 1.1 U_e (at $\theta \leq 55^\circ\text{C}$)
	Average pull-in coil consumption value	4 VA / 4 W
	Average holding coil consumption value	4 VA / 4 W
Connecting capacity	Main pole terminals	1 x 1.5 ... 10 mm ² 2 x 1.5 ... 4 mm ²
	Coil terminals	1 x 1 ... 4 mm ² 2 x 0.75 ... 2.5 mm ²

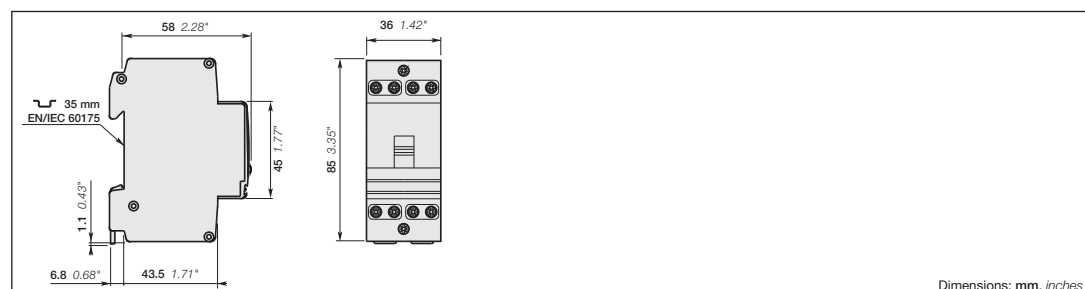
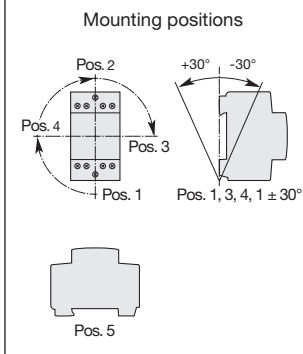



40 A
AC-1/AC-7a

EN40 Installation Contactors - Manually / Automatic Operated

AC / DC Operated



Application

The EN contactors are used mainly in buildings for switching and controlling lighting, heating, ventilation and pumps. They are part of the complete range of Din rail products and can be integrated easily in dedicated panels.

Description

The EN40 contactors are used for the control of single and three-phase loads up to 40 A. They operate with a DC coil.

EN contactors have a built-in toggle switch to select between three function modes:

Off position, automatic run (normal contactor function), manual Override with a return to Auto the next time the coil is energized.

This offers many advantages as:

You can make functional test before installation start-up, it can be used for maintenance operation, to change lamps and test it, it provide higher safety and drop out as you can switch the application manually.

The toggle switch is also used for household application like water heating where double tariff of kWh is used.

Certifications and Approvals

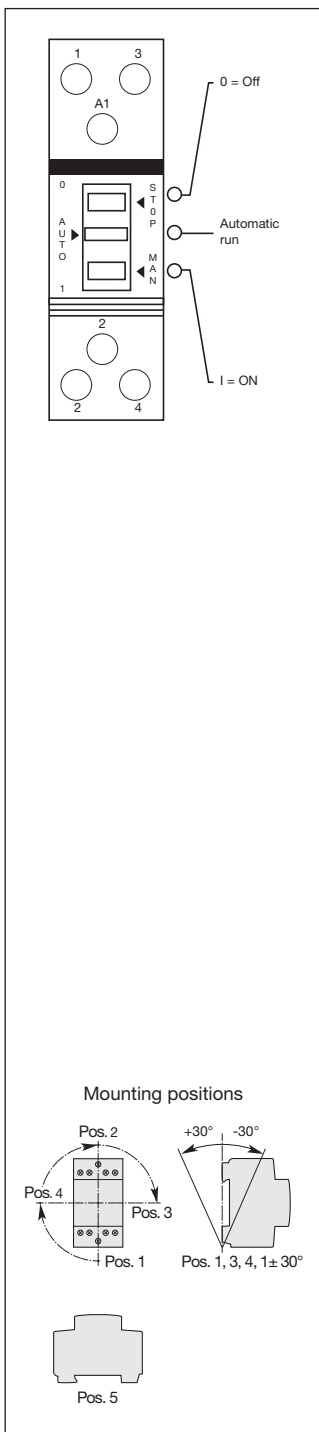

Ordering Details

Main poles	Nb of modules	Control coil voltage		Type	Order code	Pack ^(ing) pieces	Weight kg (1 pce)
		40...450 Hz	DC				
 3 4 N.O.	3	24 V	24 V	EN40-40	GHE3421101R0001	3	0.41
		110 V	110 V		GHE3421101R0004	3	0.41
		230/240 V	230/240 V		GHE3421101R0006	3	0.41
 3 3 N.O. 1 N.C.	3	24 V	24 V	EN40-31	GHE3421601R0001	3	0.41
		230/240 V	230/240 V		GHE3421601R0006	3	0.41
 3 3 N.O.	3	230/240 V	230/240 V	EN40-30	GHE3421501R0006	3	0.40
		230/240 V	230/240 V		EN40-20	GHE3421401R0006	3
 3 2 N.O.	3	230/240 V	230/240 V				

Main Technical Data

For complete technical data see 1SBC103005S0201.pdf

Main poles acc to. IEC 60947-4-1 and IEC 61095	Rated operational voltage U_e	400 V
	I_e AC-1 / AC-7a Rated operational current (for air temperature close to contactor $\theta \leq 55^\circ\text{C}$)	40 A
	P_e AC-1 Rated operational power	230 V 8.8 kW 400 V 26 kW
Magnet system	Coil operating limits (acc. to IEC 60947-4-1)	0.85 ... 1.1 U_e (at $\theta \leq 55^\circ\text{C}$)
	Average pull-in coil consumption value	5 VA / 5 W
	Average holding coil consumption value	5 VA / 5 W
Connecting capacity	Main pole terminals	Rigid 1 x 1.5 ... 25 mm ² 2 x 1.5 ... 10 mm ²
	Coil terminals	Rigid 1 x 1 ... 4 mm ² 2 x 0.75 ... 2.5 mm ²

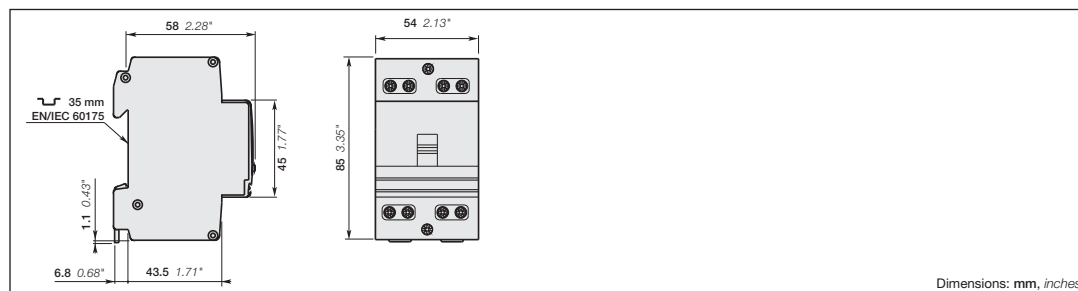

EN Installation Contactors - Manually / Automatic Operated

Technical Data

Main Pole - Utilization Characteristics according to IEC

Contactor types:	AC operated		EN20	EN24	EN40
	AC / DC operated				
Rated operational voltage U_e max.	V		250	400	
Rated frequency limits	Hz		50/60		
Utilization category AC-1 / AC-7a					
for air temperature close to contactor < 55 °C					
Max. rated operational current I _e AC-1 / AC-7a					
	N.O.	A	20	24	40
	N.C.	A	-	24	30
Short-circuit protection					
for contactors gG type fuse					
		A	20	35	63
Rated short-time withstand current I_{cw}					
at 40 °C ambient temp.,					
in free air, from a cold state					
	10 s	A	72		176
Heat dissipation per pole I_e / AC-1 / AC-7a					
		W	1		4
Max. electrical switching frequency					
– for AC-1 / AC-7a					
		cycles/h	300		
Electrical Durability					
– for AC-1 / AC-7a					
		cycles	150000		
Mechanical durability					
– millions of operating cycles					
			1		

General Technical Data

Contactor types:	AC operated		EN20	EN24	EN40
	AC / DC operated				
Rated insulation voltage U_i	V		400	500	
according to IEC 60947-4-1					
Rated impulse withstand voltage U_{imp.}	kV		6		
Standards					
IEC 60947-4-1 / EN 60947-4-1 and IEC 61095 / EN 61095					
Air temperature close to contactor					
– for operation at 0.85 ... 1.1 U _c					
		°C	-25 ... +55 (Type EN24...40: for ambient temperature > 40 °C, add ESB-DIS (1/2 module) at every second contactor)		
– for storage					
		°C	-40 ... +80		
Climatic withstand					
IEC 60068-2-30, UTE 63-100 execution 1*					
Operating altitude	m		≤ 2000		
Shock withstand					
10 g / 4 ms / axes X Y Z					
Mounting positions					
Pos 1, 3, 4, 1±30°					
Pos 5 : not allowed for EN20					
Fixing					
on rail acc. to IEC 60715 and EN 60715					

* EN20 only





EN Installation Contactors - Manually / Automatic Operated

Technical Data

Magnet System Characteristics

Contactor types:	AC operated		EN20	EN24	EN40
	AC / DC operated				
Rated operational voltage U_e max.					
- at 50 Hz	V		12 ... 400	12 ... 415	24 ... 415
- at 60 Hz	V		14 ... 380	12 ... 415	24 ... 415
	V DC		-	12 ... 415	24 ... 415
Coil operating limits acc. to IEC 60947-4-1			0.85 ... 1.1 x U_c (at $\theta \leq 55$ °C)		
Drop-out voltage in % of U_c			approx. 20 ... 75 %		approx. 10 ... 75 %
Frequency range		Hz	50/60	40 ... 450	
Coil consumption					
Average pull-in value	VA/W		8 / 5	4 / 4	5 / 5
Average holding value	VA/W		3.2 / 1.2	4 / 4	5 / 5
Operating time					
between coil energization and:					
- N.O. contact closing	ms		12	40	
between coil de-energization and:					
- N.O. contact opening	ms		12	40	

Connecting Characteristics

Contactor types:	EN20		EN24	EN40
Connecting capacity (min. ... max.)				
Main pole terminals				
Rigid		1 x mm ²	1.5 ... 10	1.5 ... 25
		2 x mm ²	1.5 ... 4	1.5 ... 10
Capacity acc. to UL/CSA		AWG	14 ... 8	16 ... 4
Coil terminals				
Rigid		1 x mm ²	0.5 ... 4	1 ... 4
		2 x mm ²	0.75 ... 2.5	
Capacity acc. to UL/CSA		AWG	18 ... 14	16 ... 10
Degree of protection			IP20	
acc. to IEC 60947-1 / EN 60947-1 and IEC 60529 / EN 60529				
Protection against direct contact in acc. with EN 50274				
All terminals				
Screwdriver type				
Main poles			Flat Ø 5 / Pozidriv 1	Flat Ø 7.5 / Pozidriv 2
Coil terminals			Flat Ø 5 / Pozidriv 1	Flat Ø 5 / Pozidriv 1
Stripping length				
Main poles	mm		10	13
Coil terminals	mm		7	
Tightening torque				
Main poles	Nm		1.2	1
Coil terminals	Nm		0.9	2.5

ESB, EN Installation Contactors

Main Accessories

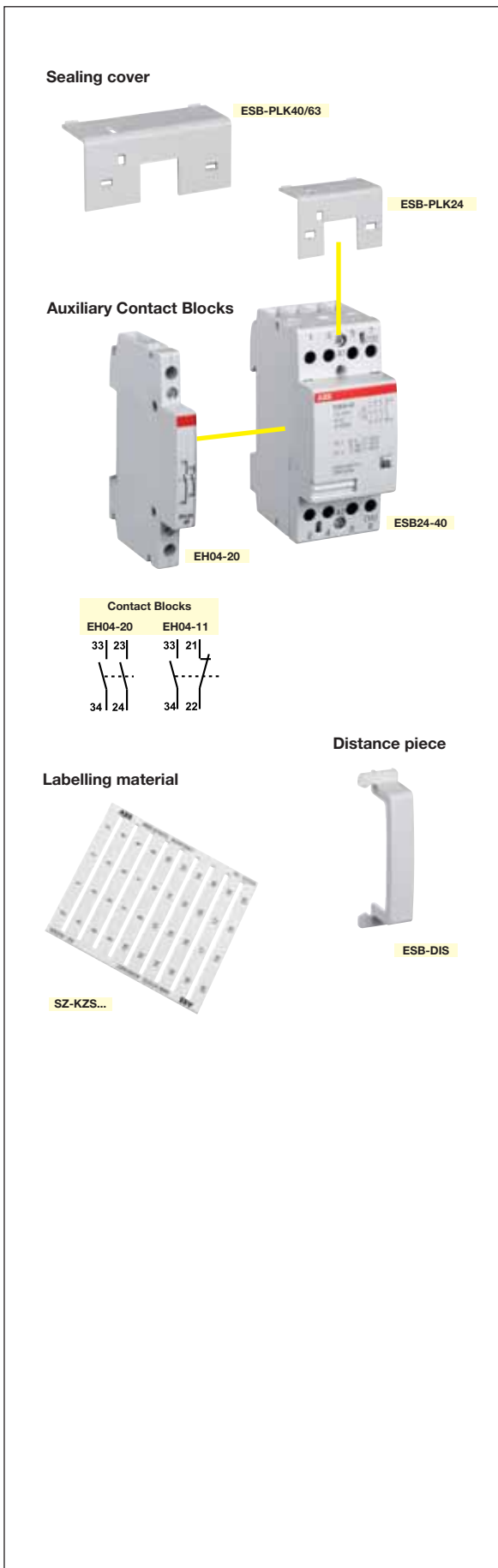

Ordering Details

Auxiliary Contact Blocks

Contactor type	Contact blocks	Type	Order code	Pack ^(n^o) pieces	Weight (1 pce) kg
ESB24...63	2 -	EH04-20	GHE3401321R0001	10	0.004
EN24...40	1 1	EH04-11	GHE3401321R0002	10	0.004

Sealing cover

Contactor type	Type	Order code	Pack ^(n^o) pieces	Weight (1 pce) kg
ESB24, EN24	ESB-PLK24	GHE3201903R0001	10	0.002
ESB40...63, EN40	ESB-PLK40/63	GHE3401903R0002	10	0.009

Distance piece

Contactor type	Type	Order code	Pack ^(n^o) pieces	Weight (1 pce) kg
ESB24...63, EN24...40	ESB-DIS	GHE3201902R0001	10	0.002

Labelling material

Contactor type	Type	Order code	Pack ^(n^o) pieces	Weight (1 pce) kg
ESB20...63, EN20...40				
Label - unlabelled*	SZ-KZS	GHS2101946R0004	30	0.008
Label - numbering 1-40	SZ-KZS/1	GHS2101946R0005	30	0.008
Label - numbering 2 * 1-20	SZ-KZS/6	GHS2101946R0010	30	0.008
Label - numbering 4 * 1-10	SZ-KZS/9	GHS2101946R0013	30	0.008
Label - numbering 4 * 11-20	SZ-KZS/10	GHS2101946R0014	30	0.008
Label - labelled L1	SZ-KZS/11	GHS2101946R0015	30	0.008
Label - labelled L2	SZ-KZS/12	GHS2101946R0016	30	0.008
Label - labelled L3	SZ-KZS/13	GHS2101946R0017	30	0.008

Note: * The unlabelled can be labelled by water-resistant and permanent marker or by means of computer-controlled labelling system (plotter).
Special labels on request: minimum quantities 50

Index

Order codes

Order code	Type	Page	Order code	Type	Page	Order code	Type	Page
GHE3201902R0001	ESB-DIS	19	GHE3291302R0004	ESB24-22	5	GHE3691302R0007	ESB63-22	7
GHE3201903R0001	ESB-PLK24	19	GHE3291302R0006	ESB24-22	5	GHE3691402R0001	ESB63-20	7
GHE3211102R0001	ESB20-20	4	GHE3291302R0007	ESB24-22	5	GHE3691402R0006	ESB63-20	7
GHE3211102R0002	ESB20-20	4	GHE3291302R1004	ESB24-22	5	GHE3691502R0006	ESB63-30	7
GHE3211102R0003	ESB20-20	4	GHE3291602R0001	ESB24-31	5	GHE3691502R0007	ESB63-30	7
GHE3211102R0004	ESB20-20	4	GHE3291602R0002	ESB24-31	5	GHE3691602R0004	ESB63-31	7
GHE3211102R0005	ESB20-20	4	GHE3291602R0003	ESB24-31	5	GHE3691602R0006	ESB63-31	7
GHE3211102R0006	ESB20-20	4	GHE3291602R0004	ESB24-31	5	GHE3691802R0006	ESB63-11	7
GHE3211102R0007	ESB20-20	4	GHE3291602R0006	ESB24-31	5	GHS2101946R0004	SZ-KZS	19
GHE3211102R1004	ESB20-20	4	GHE3291602R0007	ESB24-31	5	GHS2101946R0005	SZ-KZS/1	19
GHE3211102R1005	ESB20-20	4	GHE3291602R1004	ESB24-31	5	GHS2101946R0010	SZ-KZS/6	19
GHE3211202R0001	ESB20-02	4	GHE3291702R0001	ESB24-13	5	GHS2101946R0013	SZ-KZS/9	19
GHE3211202R0002	ESB20-02	4	GHE3291702R0002	ESB24-13	5	GHS2101946R0014	SZ-KZS/10	19
GHE3211202R0003	ESB20-02	4	GHE3291702R0003	ESB24-13	5	GHS2101946R0015	SZ-KZS/11	19
GHE3211202R0004	ESB20-02	4	GHE3291702R0004	ESB24-13	5	GHS2101946R0016	SZ-KZS/12	19
GHE3211202R0005	ESB20-02	4	GHE3291702R0006	ESB24-13	5	GHS2101946R0017	SZ-KZS/13	19
GHE3211202R0006	ESB20-02	4	GHE3291702R0007	ESB24-13	5			
GHE3211202R0007	ESB20-02	4	GHE3291702R1004	ESB24-13	5			
GHE3211202R1004	ESB20-02	4	GHE3401321R0001	EH04-20	19			
GHE3211202R1005	ESB20-02	4	GHE3401321R0002	EH04-11	19			
GHE3211302R0001	ESB20-11	4	GHE3401903R0002	ESB-PLK40/63	19			
GHE3211302R0002	ESB20-11	4	GHE3421101R0001	EN40-40	16			
GHE3211302R0003	ESB20-11	4	GHE3421101R0004	EN40-40	16			
GHE3211302R0004	ESB20-11	4	GHE3421101R0006	EN40-40	16			
GHE3211302R0005	ESB20-11	4	GHE3421401R0006	EN40-20	16			
GHE3211302R0006	ESB20-11	4	GHE3421501R0006	EN40-30	16			
GHE3211302R0007	ESB20-11	4	GHE3421601R0001	EN40-31	16			
GHE3211302R1004	ESB20-11	4	GHE3421601R0006	EN40-31	16			
GHE3211302R1005	ESB20-11	4	GHE3491102R0001	ESB40-40	6			
GHE3221101R0001	EN20-20	14	GHE3491102R0002	ESB40-40	6			
GHE3221101R0006	EN20-20	14	GHE3491102R0003	ESB40-40	6			
GHE3261101R0001	EN24-40	15	GHE3491102R0004	ESB40-40	6			
GHE3261101R0006	EN24-40	15	GHE3491102R0006	ESB40-40	6			
GHE3261501R0006	EN24-30	15	GHE3491102R0007	ESB40-40	6			
GHE3261601R0001	EN24-31	15	GHE3491102R0008	ESB40-40	6			
GHE3261601R0006	EN24-31	15	GHE3491102R1004	ESB40-40	6			
GHE3291102R0001	ESB24-40	5	GHE3491302R0001	ESB40-22	6			
GHE3291102R0002	ESB24-40	5	GHE3491302R0006	ESB40-22	6			
GHE3291102R0003	ESB24-40	5	GHE3491402R0001	ESB40-20	6			
GHE3291102R0004	ESB24-40	5	GHE3491402R0006	ESB40-20	6			
GHE3291102R0006	ESB24-40	5	GHE3491502R0001	ESB40-30	6			
GHE3291102R0007	ESB24-40	5	GHE3491502R0006	ESB40-30	6			
GHE3291102R1004	ESB24-40	5	GHE3491502R0007	ESB40-30	6			
GHE3291202R0001	ESB24-04	5	GHE3491602R0001	ESB40-31	6			
GHE3291202R0002	ESB24-04	5	GHE3491602R0006	ESB40-31	6			
GHE3291202R0003	ESB24-04	5	GHE3691102R0001	ESB63-40	7			
GHE3291202R0004	ESB24-04	5	GHE3691102R0002	ESB63-40	7			
GHE3291202R0006	ESB24-04	5	GHE3691102R0003	ESB63-40	7			
GHE3291202R0007	ESB24-04	5	GHE3691102R0004	ESB63-40	7			
GHE3291202R1004	ESB24-04	5	GHE3691102R0006	ESB63-40	7			
GHE3291302R0001	ESB24-22	5	GHE3691102R0007	ESB63-40	7			
GHE3291302R0002	ESB24-22	5	GHE3691102R0008	ESB63-40	7			
GHE3291302R0003	ESB24-22	5	GHE3691102R1004	ESB63-40	7			

Index Types

Type	Order code	Page	Type	Order code	Page	Type	Order code	Page
EH04-11	GHE3401321R0002	19		GHE3291702R0004	5		GHE3691102R0004	7
EH04-20	GHE3401321R0001	19		GHE3291702R0006	5		GHE3691102R0006	7
EN20-20	GHE3221101R0001	14		GHE3291702R0007	5		GHE3691102R0007	7
	GHE3221101R0006	14		GHE3291702R1004	5		GHE3691102R0008	7
EN24-30	GHE3261501R0006	15	ESB24-22	GHE3291302R0001	5		GHE3691102R1004	7
EN24-31	GHE3261601R0001	15		GHE3291302R0002	5	ESB-DIS	GHE3201902R0001	19
	GHE3261601R0006	15		GHE3291302R0003	5	ESB-PLK24	GHE3201903R0001	19
EN24-40	GHE3261101R0001	15		GHE3291302R0004	5	ESB-PLK40/63	GHE3401903R0002	19
	GHE3261101R0006	15		GHE3291302R0006	5	SZ-KZS	GHS2101946R0004	19
EN40-20	GHE3421401R0006	16		GHE3291302R0007	5	SZ-KZS/1	GHS2101946R0005	19
EN40-30	GHE3421501R0006	16		GHE3291302R1004	5	SZ-KZS/6	GHS2101946R0010	19
EN40-31	GHE3421601R0001	16	ESB24-31	GHE3291602R0001	5	SZ-KZS/9	GHS2101946R0013	19
	GHE3421601R0006	16		GHE3291602R0002	5	SZ-KZS/10	GHS2101946R0014	19
EN40-40	GHE3421101R0001	16		GHE3291602R0003	5	SZ-KZS/11	GHS2101946R0015	19
	GHE3421101R0004	16		GHE3291602R0004	5	SZ-KZS/12	GHS2101946R0016	19
	GHE3421101R0006	16		GHE3291602R0006	5	SZ-KZS/13	GHS2101946R0017	19
ESB20-02	GHE3211202R0001	4		GHE3291602R0007	5			
	GHE3211202R0002	4		GHE3291602R1004	5			
	GHE3211202R0003	4	ESB24-40	GHE3291102R0001	5			
	GHE3211202R0004	4		GHE3291102R0002	5			
	GHE3211202R0005	4		GHE3291102R0003	5			
	GHE3211202R0006	4		GHE3291102R0004	5			
	GHE3211202R0007	4		GHE3291102R0006	5			
	GHE3211202R1004	4		GHE3291102R0007	5			
	GHE3211202R1005	4		GHE3291102R1004	5			
ESB20-11	GHE3211302R0001	4	ESB40-20	GHE3491402R0001	6			
	GHE3211302R0002	4		GHE3491402R0006	6			
	GHE3211302R0003	4	ESB40-22	GHE3491302R0001	6			
	GHE3211302R0004	4		GHE3491302R0006	6			
	GHE3211302R0005	4	ESB40-30	GHE3491502R0001	6			
	GHE3211302R0006	4		GHE3491502R0006	6			
	GHE3211302R0007	4		GHE3491502R0007	6			
	GHE3211302R1004	4	ESB40-31	GHE3491602R0001	6			
	GHE3211302R1005	4		GHE3491602R0006	6			
ESB20-20	GHE3211102R0001	4	ESB40-40	GHE3491102R0001	6			
	GHE3211102R0002	4		GHE3491102R0002	6			
	GHE3211102R0003	4		GHE3491102R0003	6			
	GHE3211102R0004	4		GHE3491102R0004	6			
	GHE3211102R0005	4		GHE3491102R0006	6			
	GHE3211102R0006	4		GHE3491102R0007	6			
	GHE3211102R0007	4		GHE3491102R0008	6			
	GHE3211102R1004	4		GHE3491102R1004	6			
	GHE3211102R1005	4	ESB63-11	GHE3691802R0006	7			
ESB24-04	GHE3291202R0001	5	ESB63-20	GHE3691402R0001	7			
	GHE3291202R0002	5		GHE3691402R0006	7			
	GHE3291202R0003	5	ESB63-22	GHE3691302R0007	7			
	GHE3291202R0004	5	ESB63-30	GHE3691502R0006	7			
	GHE3291202R0006	5		GHE3691502R0007	7			
	GHE3291202R0007	5	ESB63-31	GHE3691602R0004	7			
	GHE3291202R1004	5		GHE3691602R0006	7			
ESB24-13	GHE3291702R0001	5	ESB63-40	GHE3691102R0001	7			
	GHE3291702R0002	5		GHE3691102R0002	7			
	GHE3291702R0003	5		GHE3691102R0003	7			

Contact us

ABB France

Low Voltage Products Division

10, rue Ampère Z.I. - B.P. 114
F-69685 Chassieu cedex / France

ABB STOTZ-KONTAKT GmbH

Eppelheimer Straße 82
D-69123 Heidelberg / Germany

You can find the address of your local sales organisation
on the ABB home page

<http://www.abb.com/contacts> -> Low Voltage products

Note:

We reserve the right to make technical changes or modify the contents of this document without prior notice. With regard to purchase orders, the agreed particulars shall prevail. ABB does not accept any responsibility whatsoever for potential errors or possible lack of information in this document.

We reserve all rights in this document and in the subject matter and illustrations contained therein. Any reproduction, disclosure to third parties or utilization of its contents – in whole or in parts – is forbidden without prior written consent of ABB.

Copyright© 2011 ABB
All rights reserved